

ROTATIONAL/PUSH/PUSH-TO-ON POTENTIOMETERS WITH SWITCH (DIMMER SWITCH)

WH168(B39S1)

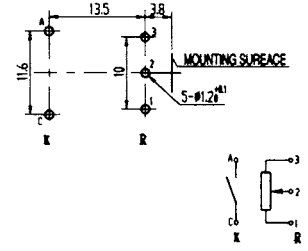

WH116AK-1 (PUSH TYPE)

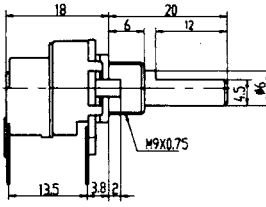
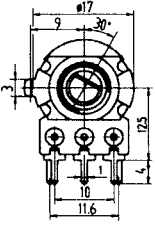
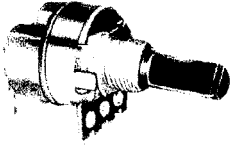
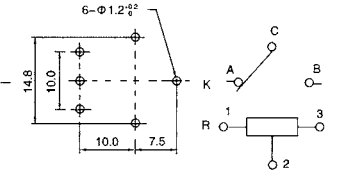
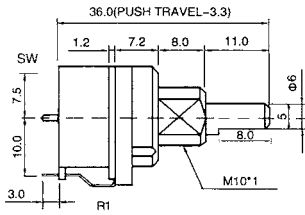
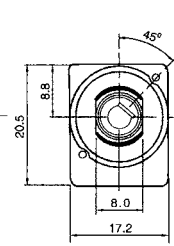

WH116AK-2 (PUSH TYPE)

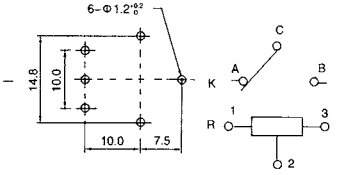
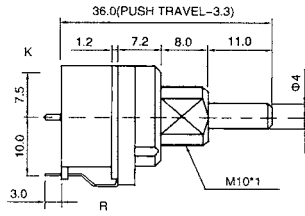
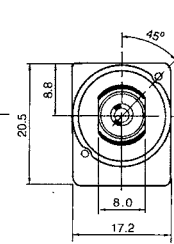

WH116AK-4-R (PUSH TYPE)

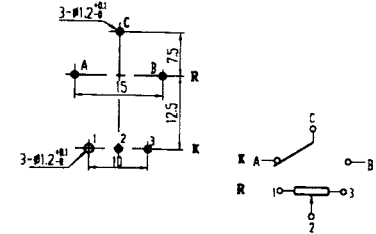
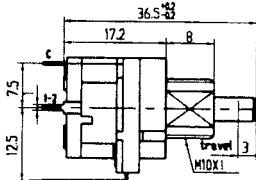
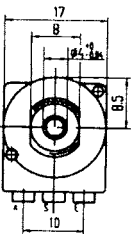
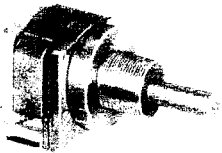

ROTATIONAL/PUSH POTENTIOMETERS WITH SWITCH (DIMMER SWITCH)

RV16C-40-1 (ROTARY TYPE)

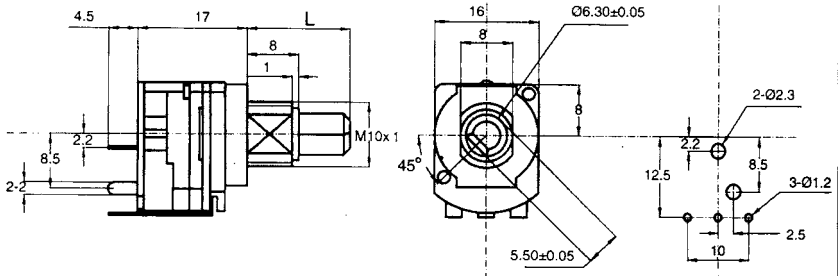

RV16C-40-2 (ROTARY TYPE)

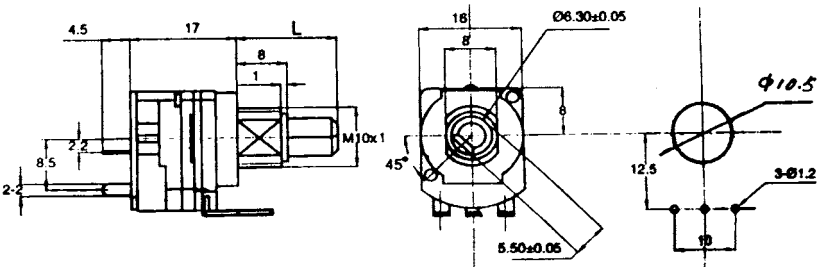

RV16C-40-3 (ROTARY TYPE)

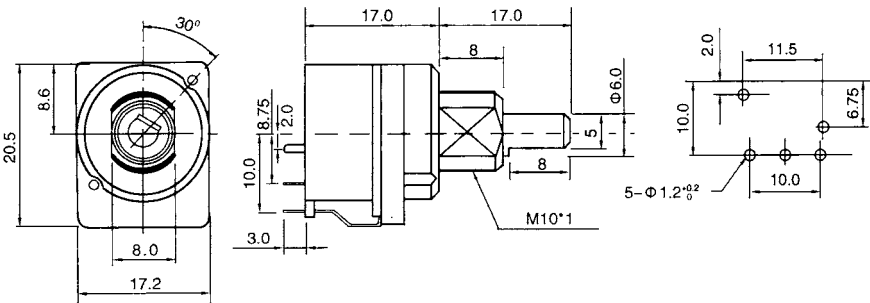
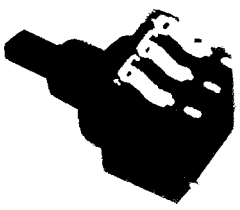

WH0162

